

GETTING STARTED



CHAPTER 1

In this Chapter...

Introduction.....	1-2
Conventions Used.....	1-3
Mounting Clips – New Style.....	1-3
Product Overview	1-4
Part Number Key – Touch Panels.....	1-5
EZTouch Conversion and Mounting	1-6
EZTouch Touch Panel Cross Reference to C-more	1-7
Quick Start Steps	1-9
Step 1 – Unpack and Inspect.....	1-9
Step 2 – Assemble Temporary Support Stand.....	1-10
Step 3 – Install Optional Hardware Accessories.....	1-11
Step 4 – Become Familiar with Available Communication Ports.....	1-12
Step 5 – Install the Programming Software and Develop a Project	1-13
Step 6 – Connect Touch Panel to Computer	1-14
Step 7 – Provide Power to the Touch Panel.....	1-15
Step 8 – Access the Touch Panel Setup Screens.....	1-16
Step 9 – Choose Touch Panel to Device Protocol & Cables.....	1-17
Step 10 – Connect Touch Panel to PLC.....	1-20

Introduction

1

The Purpose of this Manual

Thank you for purchasing our *C-more*[®] Touch Panel family of products. This manual describes AutomationDirect.com's *C-more* Touch Panels, their specifications, included components, available accessories and provides you with important information for installation, connectivity and setup. The manual shows you how install, wire and use the products. It also helps you understand how to interface the panels to other devices in a control system.

This user manual contains important information for personnel who will install the touch panels and accessories, and for the personnel who will be programming the panel. If you understand control systems that make use of operating interfaces such as the *C-more* touch panels, our user manuals will provide all the information you need to get, and keep your system up and running.

Supplemental Manuals

If you are familiar with industrial control type devices, you may be able to get up and running with just the aide of the Quick Start Guide that is included with each touch panel. You can also refer to the On-line help that is available in the *C-more* programming software for more information about programming the panel. The accessories include data sheets that will help with installing the accessories.

Technical Support

We strive to make our manuals the best in the industry. We rely on your feedback to let us know if we are reaching our goal. If you cannot find the solution to your particular application, or, if for any reason you need technical assistance, please call us at:

770-844-4200

Our technical support group will work with you to answer your questions. They are available Monday through Friday from 9:00 A.M. to 6:00 P.M. Eastern Time. We also encourage you to visit our web site where you can find technical and non-technical information about our products and our company.

<http://cmore.automationdirect.com>

If you have a comment, question or suggestion about any of our products, services, or manuals, please fill out and return the 'Suggestions' card that was included with this manual.

Conventions Used



When you see the “notepad” icon in the left-hand margin, the paragraph to its immediate right will be a special note. The word **NOTE**: in boldface will mark the beginning of the text.



When you see the “exclamation mark” icon in the left-hand margin, the paragraph to its immediate right will be a warning. This information could prevent injury, loss of property, or even death (in extreme cases). The word **WARNING**: in boldface will mark the beginning of the text.

Key Topics for Each Chapter

The beginning of each chapter will list the key topics that can be found in that chapter.

Getting Started	
In This Chapter...	
General Information	1-2
Specifications	1-4

Mounting Clips – New Style



NOTE: *C-more* touch panels shipped prior to approximately **April 2006** had a slightly different mounting clip design. All of the drawings and illustrations in this issue of the Hardware User Manual are shown with the newer design. **Appendix C: Mounting Clips Prior April 2006** contains drawings and illustrations of the original designed mounting clips for your reference.

Product Overview

1



Some of the features designed into the product to provide excellent hardware and software are listed below.

- Analog touch screen (no touch cell boundaries). The touchscreen is designed to respond to a single touch. If it is touched at multiple points at the same time, an unexpected object may be activated.
- Plenty of memory and methods to get data in/out of the panel
- Overlapping active devices on the touch screen
- 65,536 colors for enhanced graphics
- Screen resolutions up to 1024 X 768 pixels
- Built-in project simulation; test on PC while developing
- Serial RS232, RS422/485 and Ethernet 10/100Base-T communications (Ethernet available on full feature units only.)
- Programming via USB or Ethernet (Ethernet available on full feature units only.)
- Optional AC/DC power adapter (EA-AC)
- Bright backlight bulbs
- Animation of bitmaps and objects
- 4,000 built-in symbols, classic fonts: 6x8, 8x16, 8x32, 8x64, 16x16, 16x32, 16x64, 32x16, 32x32, 32x64, and Windows fonts
- PID face plate, trending, alarming and a recipe database
- Event Manager to trigger actions based on assigned state changes, schedules, PLC tag names, etc. setup in a database environment. The event can also trigger a sound byte, initiate a screen capture, send a data file (FTP), send an E-mail, etc.
- Select unique background screens for each created screen
- Trend Data logging
- Internet Remote Access
- Built-in FTP client/server, E-mail client, and Web server
- Audio output port - stereo, requires amplifier and speaker(s)

Part Number Key – Touch Panels

The *C-more* touch panel part numbers consist of the following key:

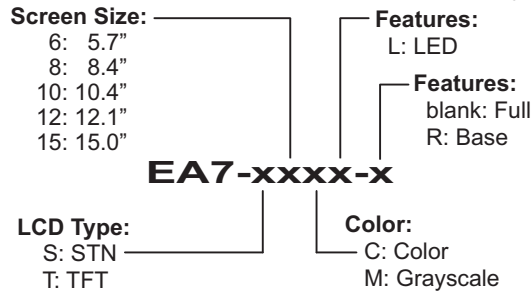

Product label examples:

EA7-T6CL-R

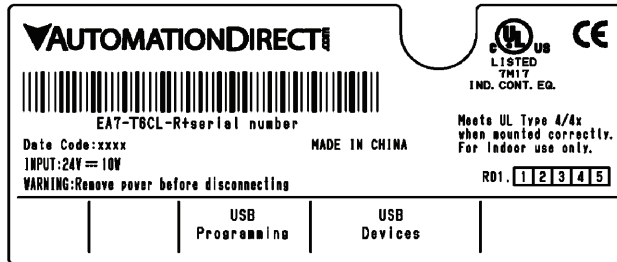

EA7-T15C

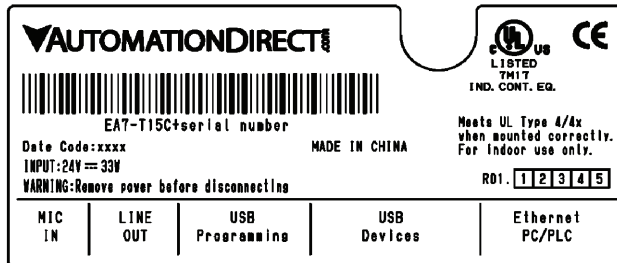

Serial Number and Date Code formats:

Serial Number = [Part Number]+[YYMDDFNNN]

- YY:** Year (05–99 --- e.g. 05 = 2005)
- M:** Month (1–9, X, Y, Z --- e.g. X = Oct.)
- DD:** Day (1–31)
- F:** Manufacturing Site (0–9, A–Z)
- NNN:** Sequence number for the date listed (000–999)

Date Code = **YMMF**

- Y:** Year (0–9 --- e.g. 07 = 2007)
- MM:** Month (01–12 --- e.g. X = Oct.)
- F:** Manufacturing Site (0–9, A–Z)

EZTouch Conversion and Mounting

C-more panels are a drop-in replacement for EZTouch panels from *AutomationDirect*. They fit the same panel cutout*. The *C-more* software will convert your legacy EZTouch project (created with EZTouch Edit ver. 3.1a) automatically with no changes to the project required.** Just open your old EZTouch project in the new *C-more* Programming Software, connect the USB cable, and click “Send to Panel”. The conversion is automatic and you will benefit immediately from:

- A better looking display
- A brighter screen
- Longer backlight bulb life
- Wider temperature tolerance
- A two year warranty



NOTE: EZTouch projects most have been created with EZTouch Edit software version 3.1a to assure proper project conversion.

Now, there are hundreds of new features you may want to take advantage of, but it’s nice to know that you can be up and running your existing EZTouch project in just a few minutes.

C-more accepts the same PLC communications and networking cables that you are using with EZTouch. The 24 VDC power connections accept the same DC wiring that you used for EZTouch, and now there is a removable terminal block connector. Only the programming cable is different - you no longer have to buy a proprietary serial cable to program your touch panel. *C-more* uses a standard USB cable or an Ethernet (CAT5) connection for programming.



* If you have an old 6” non-slim bezel EZTouch panel you will need our 6” Adapter Plate, part number EA-6-ADPTR, see the chapter on accessories.



** The project conversion utility is a great feature. However the user must take full responsibility in ensuring the conversion works to their satisfaction.



Example of a *C-more* 6” touch panel mounted into an existing EZTouch non-slim bezel cutout using the *C-more* 6” adapter plate.

EZTouch Touch Panel Cross Reference to C-more

EZTouch		C-more*	
EZTouch 6", grayscale STN (0–45 °C)		C-more 6" Adapter	C-more 6", grayscale STN (0–50 °C)
EZ-S6M-R	Requires:	EA-6-ADPTR	 EA7-S6M-R
EZ-S6M-RS			
EZ-S6M-F	Requires:	EA-6-ADPTR	 EA7-S6M (includes Ethernet)
EZ-S6M-FS			

EZTouch		C-more*	
EZTouch 6", 128 Color STN (0–45 °C)		C-more 6" Adapter	C-more 6", 65,536 Color TFT (0–50 °C)
EZ-S6C-K	Requires:	EA-6-ADPTR	 EA7-T6CL-R
EZ-S6C-KS			
EZ-S6C-F	Requires:	EA-6-ADPTR	 EA7-T6CL (includes Ethernet)
EZ-S6C-FS			
EZ-S6C-FST			

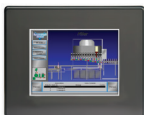
EZTouch		C-more*	
EZTouch 8", 128 Color STN (0–40 °C)		C-more 8", 65,536 Color TFT (0–50 °C)	
EZ-S8C-F		 EA7-T8C (includes Ethernet)	
EZ-S8C-FS			
EZ-S8C-FST			



*Note: All C-more touch panels meet UL type 4X when mounted on a flat surface of a type 4X indoor use only enclosure. Non-FDA

EZTouch Touch Panel Cross Reference to *C-more* (cont'd)

1

EZTouch	<i>C-more</i> *
EZTouch 10", 128 Color TFT (0–50 °C)	<i>C-more</i> 10", 65,536 Color TFT (0–50 °C)
EZ-S10C-F	 <p>EA7-T10C (includes Ethernet)</p>
EZ-T10C-FS	
EZ-T10C-FST	
EZ-T10C-FSE	

EZTouch	<i>C-more</i> *
No 12" EZTouch available	<i>C-more</i> 12", 65,536 Color TFT (0–50 °C)
	 <p>EA7-T12C (includes Ethernet)</p>

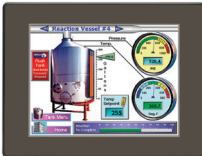
EZTouch	<i>C-more</i> *
EZTouch 15", 128 Color TFT (0–45 °C)	<i>C-more</i> 15", 65,536 Color TFT (0–50 °C)
EZ-T15C-FS	 <p>EA7-T15C (includes Ethernet)</p>
EZ-T15C-FST	
EZ-T15C-FSE	



***NOTE:** All *C-more* touch panels meet UL type 4X when mounted on a flat surface of a type 4X indoor use only enclosure. Non-FDA

Quick Start Steps

Step 1 – Unpack and Inspect

a.) Unpack the *C-more* Touch Panel from its shipping carton. Included in the carton are the following:

- *C-more* Touch Panel
- cutout template
- mounting clips
- temporary support stand
- DC power connector
- gasket
- Quick Start Guide, p/n EA-QSG

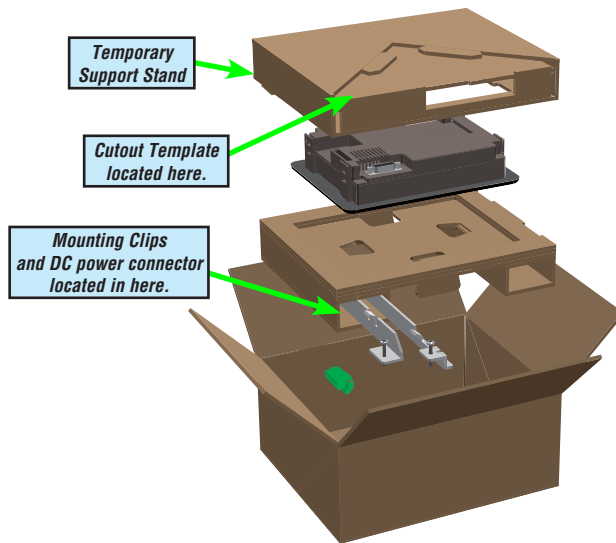

Shipping Carton Contents

b.) Unpack any accessories that have been ordered, such as: AC/DC Power Adapter, Expansion Assembly, CompactFlash memory, programming cable, communications cable, etc.

c.) Inspect all equipment for completeness. If anything is missing or damaged, immediately call the *AutomationDirect*® returns department @ 1-800-633-0405.

Optional Accessories

AC Power Adapter
EA-AC



Expansion Assembly
EA-EXP-OPT



Compact Flash Card
EA-CF-CARD



Step 2 – Assemble Temporary Support Stand

1

6" & 8" Touch Panel – Temporary Stand

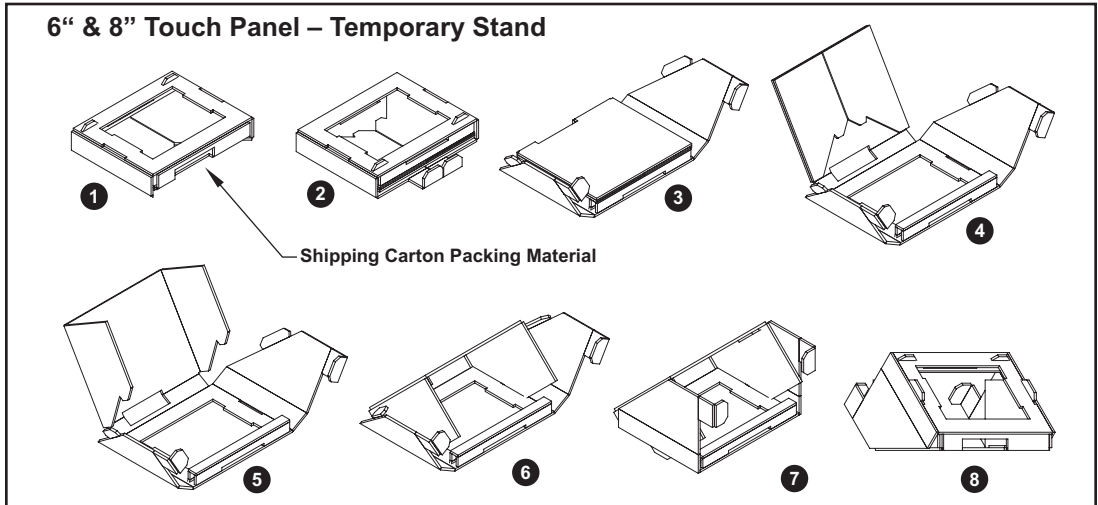

10", 12" & 15" Touch Panel – Temporary Stand

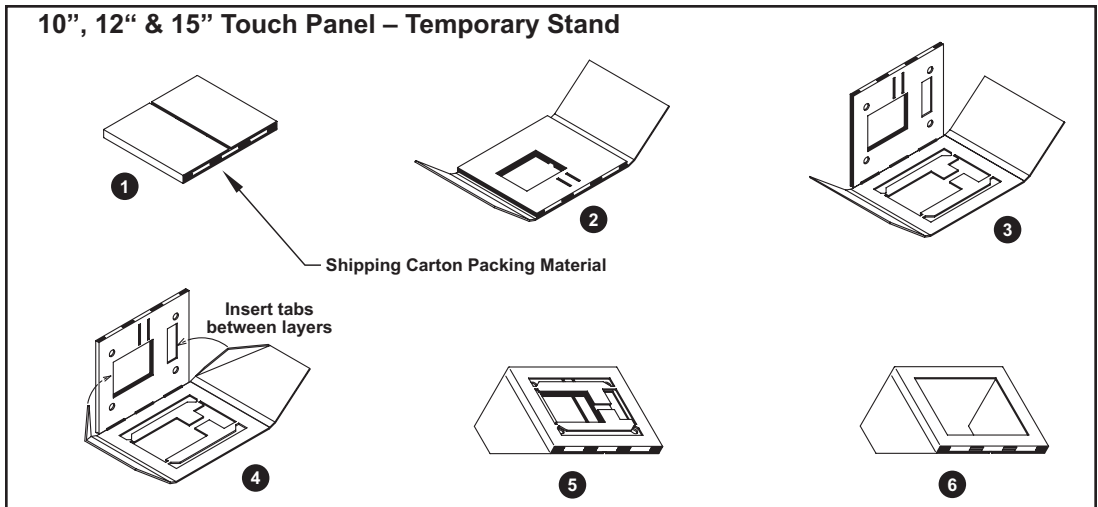

NOTE: See **Chapter 4: Installation and Wiring** for **C-more** touch panel installation information including cutout dimensions and mounting clearances.

Step 3 – Install Optional Hardware Accessories



NOTE: CompactFlash memory card designations – **CF Slot #1** is at the top of the panel and **CF Slot #2** is the CF Card Interface Module, p/n EA-CF-IF.

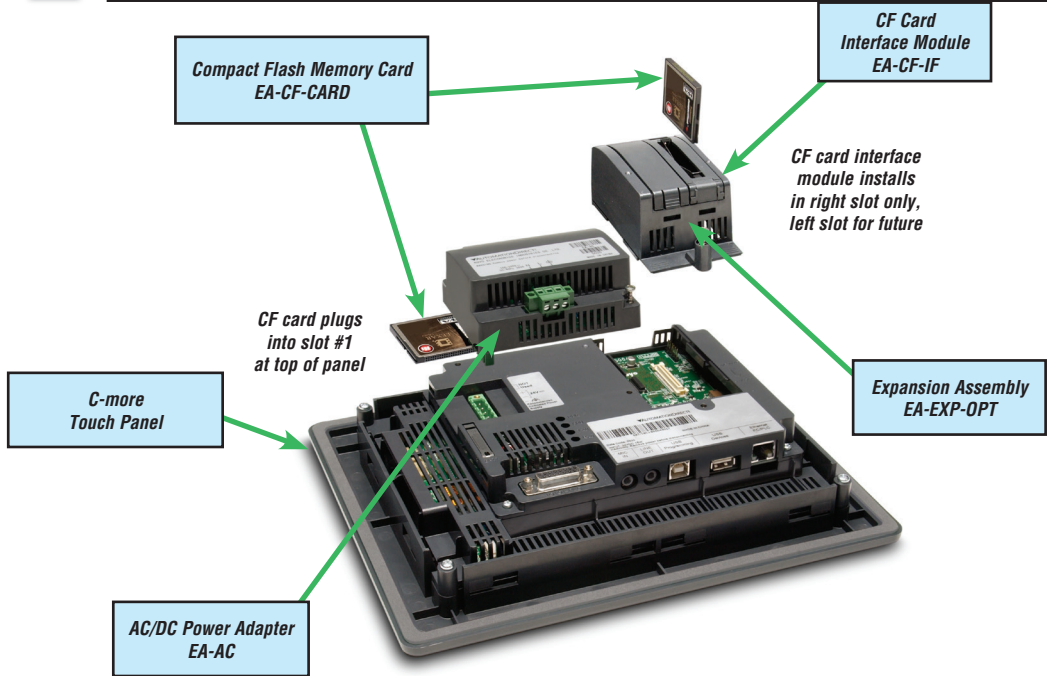

NOTE: The **C-more** 6" touch panels will fit into the existing cutout of any **EZTouch** 6" slim bezel panel. Use the **C-more** 6" Adapter Plate, p/n EA-6-ADPTR, to install **C-more** 6" panels into existing cutouts of **EZTouch** 6" non-slim (rounded bezel) panels.

Optional Accessories

6" Adapter Plate
EA-6-ADPTR

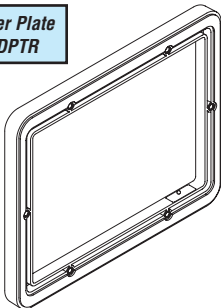

15-pin Terminal Block Adapter
EA-COMCON-3

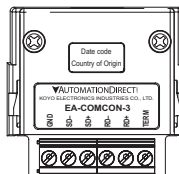

15-pin 90 Degree Comm. Port Adapter
EA-ADPTR-4

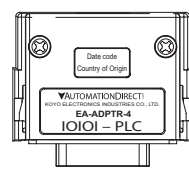

Step 4 – Become Familiar with Available Communication Ports

1

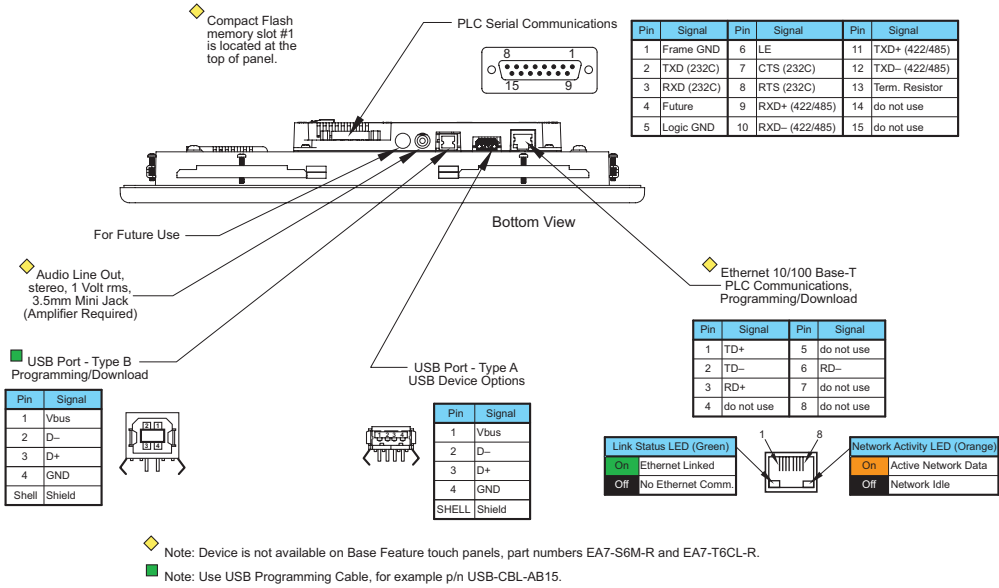

NOTE: See **Chapter 2: Specifications** and **Chapter 6: PLC Communications** for additional details on the available communication ports, protocols and cables.

Step 5 – Install the Programming Software and Develop a Project

Following are the minimum system requirements for running *C-more* Programming Software, p/n EA-PGMSW, on a PC:

- Personal Computer with a 333 MHz or higher processor (CPU) clock speed recommended; Intel® Pentium/Celeron family, or AMD® K6/Athlon/Duron family, or compatible processor recommended
- Keyboard and Mouse or compatible pointing device
- Super VGA color video adapter and monitor with at least 800 x 600 pixels resolution (1024 x 768 pixels recommended)
64K color minimum
- 300 MB free hard-disk space
- 128 MB free RAM (512 MB recommended); 512 MB free RAM (1 GB recommended) for Vista
- CD-ROM or DVD drive for installing software from the CD
- USB port or Ethernet 10/100 Mbps port for project transfer from software to touch panel (Ethernet port not available on -R models)
- Operating System - Windows® XP Home / Professional Edition Service Pack 2 (32 bit) , Windows 2000 with Service Pack 4, Windows Vista® (32 or 64 bit) or Windows 7 (32 or 64 bit), Windows 8

Insert the supplied CD-ROM into the PC's CD-ROM drive and follow the instructions. If you need assistance during the software installation, please refer to the supplied Software Installation Guide or call the AutomationDirect Technical Support team @ 770-844-4200.

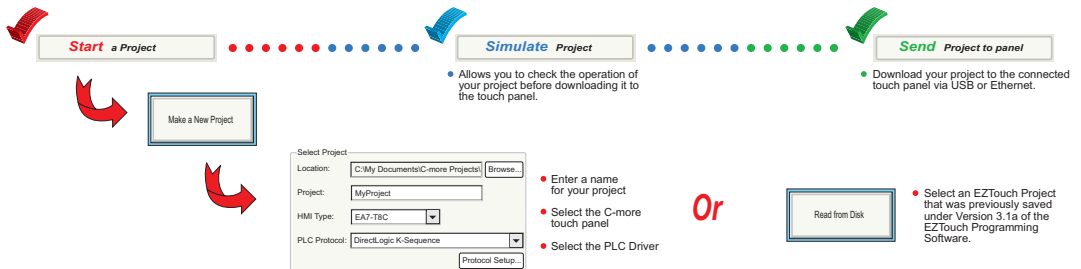

Step 6 – Connect Touch Panel to Computer

- Connect a USB Programming Cable, such as p/n USB-CBL-AB15, from an USB type A port on the PC to the USB type B programming port on the *C-more* touch panel
- or connect the *C-more* touch panel and PC together via an Ethernet hub or switch, and CAT5 Ethernet cables (full feature panels only)
- or use an Ethernet crossover cable directly between the *C-more* touch panel Ethernet port and the PC Ethernet port (full feature panels only)

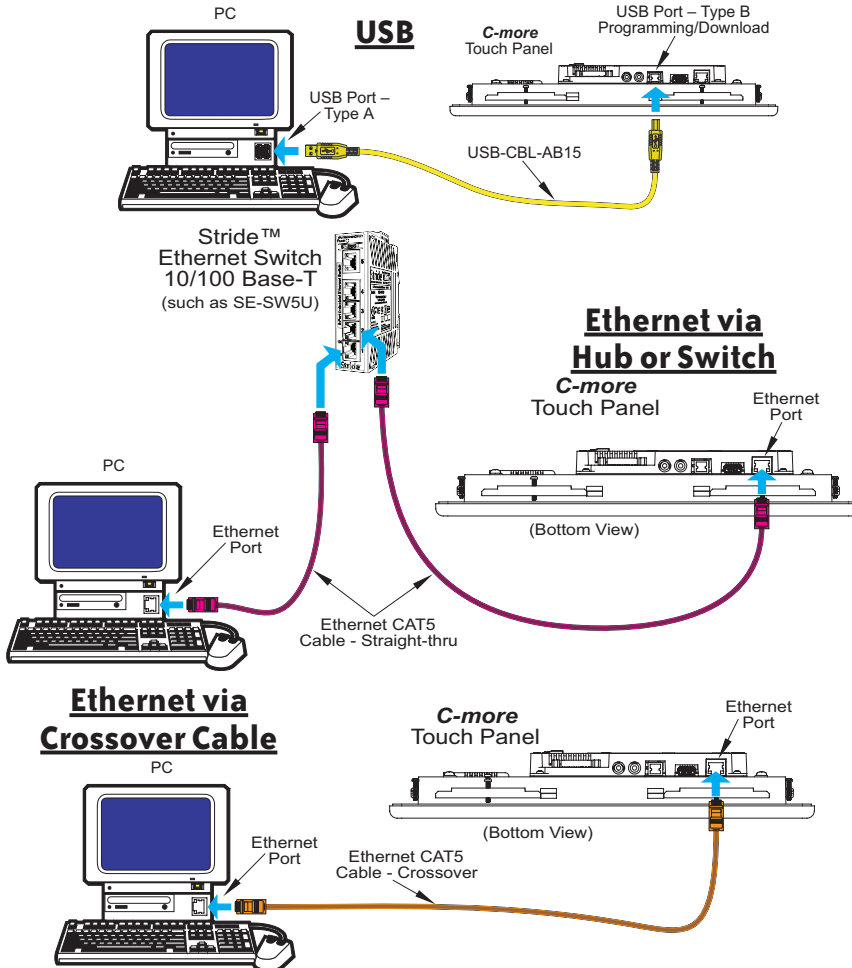

NOTE: On power up, the touch panel will either copy the project from its internal Flash memory to its internal SDRAM memory and run the project, or if a CompactFlash memory card is plugged into the CF1 slot, then any project contained on the CF memory card will be copied to the panel's internal SDRAM memory and be run. The memory of a CompactFlash card on CF1 will override the panel's internal Flash memory on power up or reboot, even if the CompactFlash memory card does not contain a project.

Step 7 – Provide Power to the Touch Panel

- Connect a dedicated 24 VDC (20.4 - 28.8 VDC) switching power supply rated at a minimum of 1.5 A to the DC connector on the rear of the *C-more* touch panel, include wiring the ground terminal to a proper equipment ground
- or install a *C-more* AC/DC Power Adapter, EA-AC, to the rear of the touch panel and connect an AC voltage source of 100-240 VAC, 50/60Hertz, to its AC connector (see note below)
- then turn on the power source and check the LED status indicators on the rear of the *C-more* touch panel for proper indication



NOTE: The AC/DC Power Adapter, EA-AC, is for *C-more* touch panels only. The adapter is powered from a 100-240 VAC, 50/60 Hertz power source. The adapter provides 24 VDC @ 1.5 A. Power Fault features help protect data being logged to CompactFlash during power failures. The *C-more* panel must have firmware version 1.21 Build 6.18E or higher for proper operation.

DC Wiring

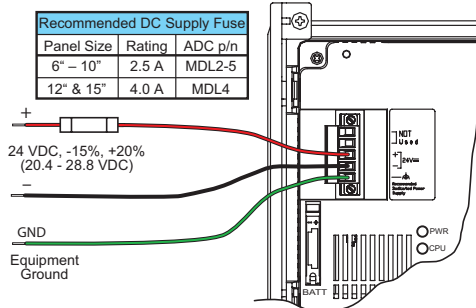

WARNING: The AC/DC Power Adapter is not recommended for use with the EA7-T15C touch panel when operating temperatures are expected to exceed 40 °C [104 °F].

AC Wiring

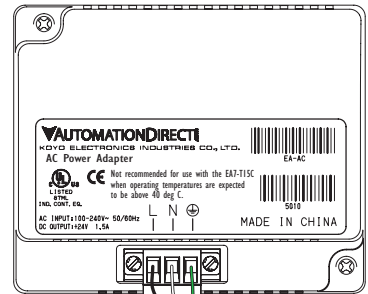

Tightening Torque	
Power supply cable torque	71 - 85 oz-in (0.5 - 0.6 Nm)
Power connector mounting torque	71 - 85 oz-in (0.5 - 0.6 Nm)
Mounting flange screw torque	57 - 71 oz-in (0.4 - 0.5 Nm)



NOTE: Use 60 / 75 °C copper conductors only.

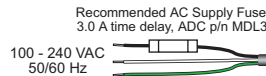

C-more LED Status Indicators

CPU Status LED (Green, Orange & Red)	
Off	Power Off
Green	Normal – CPU Run State
Red	Memory Error
Blinking Red	Operating System not found
Blinking Orange	LCD Backlight Failure
Blinking Green	Power Loss Detection

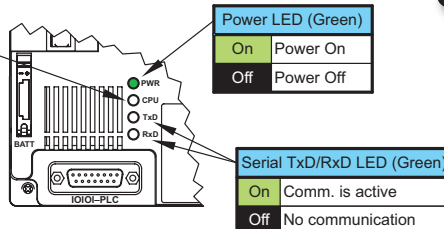

Rear View

Step 8 – Access the Touch Panel Setup Screens

- 1 Access the Main Menu of the touch panel System Setup Screens by pressing the extreme upper left corner of the panel display area for three (3) seconds as shown below.
- Adjust the time and date for the panel by pressing the Setting button on the Main Menu, then press the Adjust Clock button on the Setting screen.
- Use the right pointing arrows for the time or date display to select the unit to change. Use the up and down arrows to increment or decrement the value for the selected unit.
- Press OK when done to accept the changes to the time and date that is retained in the touch panel's battery backed memory, or press Cancel to exit the Adjust Clock setup screen without making any changes.
- Press the Main Menu button on the Setting screen and then the Exit button on the Main Menu screen to return to the application screen.

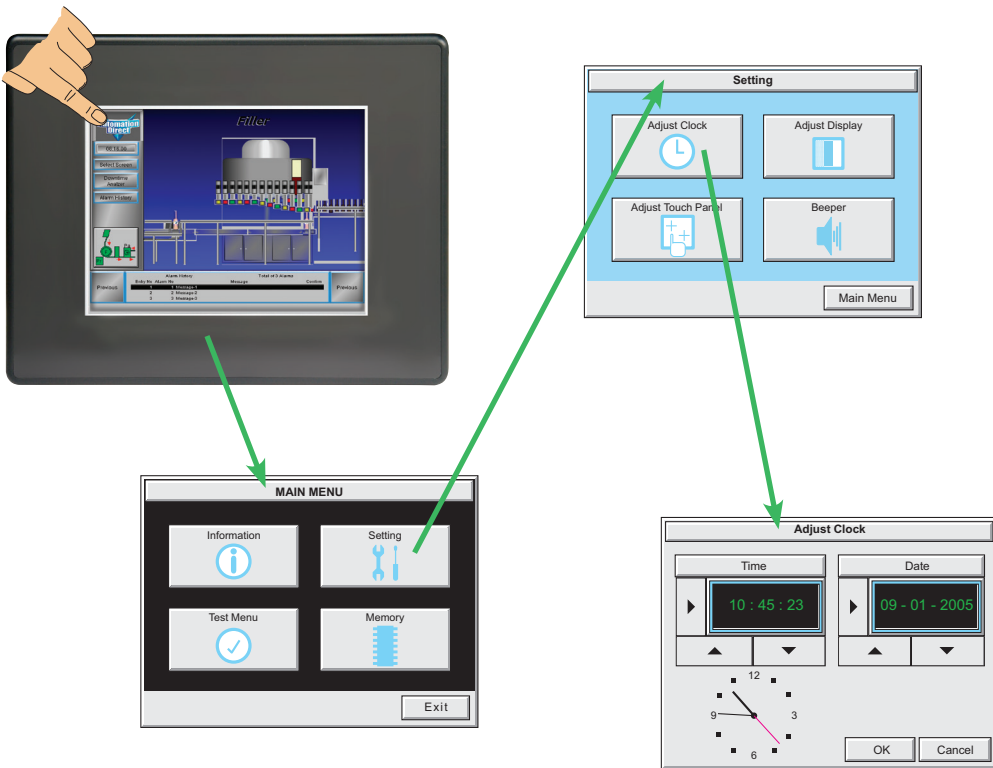

NOTE: When using an Ethernet connection, by default the panel is set for DHCP IP addressing. If it can not find a DHCP server, the panel will automatically assign an IP address. The IP address can be changed by the user from the programming software or by accessing the IP address setting screen as shown on page 5-19 and detailed on page 5-24. See **Chapter 5 - System Setup Screens** for details on other setup screen settings and functions.

Step 9 – Choose Touch Panel to Device Protocol & Cables

Compatibility Table				
Model		Protocols		
AutomationDirect	Productivity3000		P3000 Serial P3000 Ethernet	
	CLICK		Modbus (CLICK)	
	DL05/DL06	all	K-Sequence Direct NET Modbus (Koyo addressing)	
		H0-ECOM/H0-ECOM100	Direct LOGIC Ethernet	
	DL105	all	K-Sequence	
	DL205	D2-230	K-Sequence	
		D2-240	K-Sequence Direct NET	
		D2-250/D2-250-1/D2-260	K-Sequence Direct NET	
			Modbus (Koyo addressing)	
		D2-240/D2-250-1/D2-260 Using DCM	Direct NET Modbus (Koyo addressing)	
		H2-ECOM/H2-ECOM100	Direct LOGIC Ethernet	
	DL305	D3-330/330P (Requires the use of a Data Communications Unit)		Direct NET
		D3-340		Direct NET
		D3-350	K-Sequence Direct NET	
			Modbus (Koyo addressing)	
	D3-350 DCM		Direct NET Modbus (Koyo addressing)	
	DL405	D4-430	K-Sequence Direct NET	
		D4-440	K-Sequence Direct NET	
			K-Sequence Direct NET	
		D4-450	K-Sequence Direct NET	
			Modbus (Koyo addressing)	
		All with DCM	Direct NET Modbus (Koyo addressing)	
	H4-ECOM/H4-ECOM100		Direct LOGIC Ethernet	
	H2-WinPLC (Think & Do) Live V5.2 or later and Studio any version		Think & Do Modbus RTU (serial port)	
	H2-WinPLC (Think & Do) Live V5.5.1 or later and Studio V7.2.1 or later		Think & Do Modbus TCP/IP (Ethernet port)	
	GS Drives		GS Drives Serial GS Drives TCP/IP (GS-EDRV)	
	SOLO Temperature Controllers		SOLO Temperature Controller	

PLC Compatibility Table continued on the next page.

Step 9 – Choose Touch Panel to PLC Protocol & Cables (cont'd)

1

Compatibility Table (cont'd)		
Model		Protocols
Allen-Bradley	MicroLogix 1000, 1100, 1200, 1400, 1500, SLC 5-01/02/03	DH485/AIC/AIC+
	MicroLogix 1000, 1100, 1200, 1400 and 1500	DF1 Half Duplex; DF1 Full Duplex
	SLC 5-03/04/05	
	ControlLogix™, CompactLogix™, FlexLogix™	
	PLC-5	DF1 Full Duplex
	ControlLogix, CompactLogix, FlexLogix - Tag Based	DF1 Half Duplex; DF1 Full Duplex
	ControlLogix, CompactLogix, FlexLogix - Generic I/O Messaging	EtherNet/IP Server
	ControlLogix, CompactLogix, FlexLogix - Tag Based	EtherNet/IP Client
	MicroLogix 1100, 1400 and SLC 5/05, via native Ethernet port	
MicroLogix 1000, 1100, 1200, 1400, 1500, SLC 5-03/04/05, all via ENI adapter		
GE	90/30, 90/70, Micro 90, VersaMax Micro	SNPX
Mitsubishi	FX Series	FX Direct
	Q02, Q02H, Q06H, Q12H, Q25H	Q CPU
	Q, QnA Serial	QnA Serial
	Q, QnA Ethernet	QnA Ethernet
Modicon	984 CPU, Quantum 113 CPU, AEG Modicon Micro Series 110 CPU: 311-xx, 411-xx, 512-xx, 612-xx	Modbus RTU
	Other devices using Modicon Modbus addressing	Modbus RTU TUModbus TCP/IP
Omron	C200 Adapter, C500	Host Link
	CJ1/CS1 Serial	FINS
	CJ1/CS1 Ethernet	
Siemens	S7-200 CPU, RS-485 Serial	PPI
	S7-200 CPU, S7-300 CPU, S7-1200 CPU; Ethernet	Ethernet ISO over TCP

Step 9 – Choose Cables continued on next page.

Step 9 – Choose Touch Panel to PLC Protocol & Cables (cont'd)

Purchased Cable Description	Cable Part Number
AutomationDirect Productivity Series, CLICK, Direct LOGIC PLC RJ-12 port, DL05, DL06, DL105, DL205, D3-350, D4-450 & H2-WINPLC (RS-232C)	EA-2CBL
Direct LOGIC (VGA Style) 15-pin port DL06, D2-250 (250-1), D2-260 (RS-232C)	EA-2CBL-1
Direct LOGIC PLC RJ-11 port, D3-340 (RS-232C)	EA-3CBL
Direct LOGIC DL405 PLC 15-pin D-sub port, DL405 (RS-232C)	EA-4CBL-1
Direct LOGIC PLC 25-pin D-sub port, DL405, D3-350, DL305 DCU and all DCM's (RS-232C)	EA-4CBL-2
Allen-Bradley MicroLogix 1000, 1100, 1200, 1400, 1500 (RS-232C)	EA-MLOGIX-CBL
Allen-Bradley SLC 5-03/04/05, ControlLogix, CompactLogix, FlexLogix DF1 port (RS-232C)	EA-SLC-232-CBL
Allen-Bradley PLC-5 DF1 port (RS-232C)	EA-PLC5-232-CBL
Allen-Bradley MicroLogix, SLC 5-01/02/03, PLC5 DH485 port (RS-232C)	EA-DH485-CBL
GE 90/30, 90/70, Micro 90, VersaMax Micro 15-pin D-sub port (RS-422A)	EA-90-30-CBL
MITSUBISHI FX Series 25-pin port (RS-422A)	EA-MITSU-CBL
MITSUBISHI FX Series 8-pin mini-DIN (RS-422A)	EA-MITSU-CBL-1
OMRON Host Link (C200 Adapter, C500) (RS-232C)	EA-OMRON-CBL



NOTE 1: The above list of pre-made communications cables may be purchased. See **Chapter 6: PLC Communications** for wiring diagrams of additional **user constructed** cables. Chapter 6 also includes wiring diagrams for the pre-made cables.

NOTE 2: EZTouch serial PLC communication cables are compatible with **C-more** touch panels.

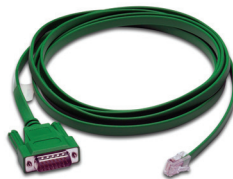
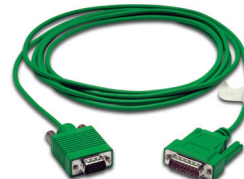
EA-2CBL**EA-2CBL-1**

Pre-made cable examples

Step 10 – Connect Touch Panel to PLC

- Connect the serial communications cable between the *C-more* touch panel and the PLC
- or connect the *C-more* touch panel and PLC together via an Ethernet hub or switch, and CAT5 Ethernet cables (full feature panels only)
- or use an Ethernet crossover cable directly between the *C-more* Ethernet port and the PLC Ethernet port (full feature panels only)

